

JVC



ENGLISH

DEUTSCH

FRANÇAIS

NETERLANDS

CD RECEIVER
CD-RECEIVER
RECEPTEUR CD
CD-RECEIVER

KD-S611

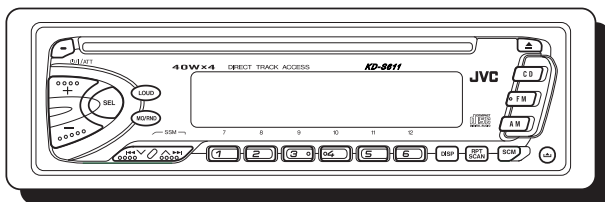
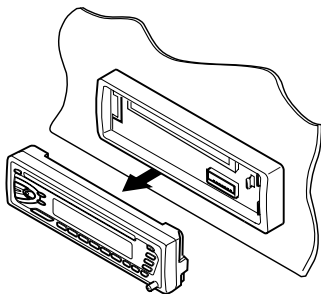

COMPACT
disc
DIGITAL AUDIO

For installation and connections, refer to the separate manual.

Für den Einbau und die Anschlüsse siehe das eigenständige Handbuch.

Pour l'installation et les raccordements, se référer au manuel séparé.

Bijzonderheden over de installatie en aansluiting van het apparaat vindt u in de desbetreffende handleiding.

INSTRUCTIONS

BEDIENUNGSANLEITUNG
MANUEL D'INSTRUCTIONS
GEBRUIKSAANWIJZING

GET0005-001A
[E]

Position And Reproduction Of Labels

Bottom panel of the main unit

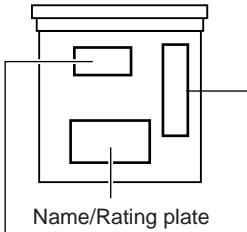

DANGER: Invisible laser radiation when open and interlock failed or defeated. AVOID DIRECT EXPOSURE TO BEAM. (e)

ADVARSEL: Usynlig laserstråling ved åbning, når sikkerhedsafbrydere er ude af funktion. Undgå udsættelse for stråling. (d)

WARNING: Osynlig laserstråling när denna del är öppnad och spärren är urkopplad. Beträkta ej strålen. (s)

VARO: Avattaessa ja suojalukitus ohitettaessa olet alltiina näkymättömälle lasersäteilylle. Älä katso säteeseen. (f)

IMPORTANT FOR LASER PRODUCTS

Precautions:

1. CLASS 1 LASER PRODUCT
2. **DANGER:** Invisible laser radiation when open and interlock failed or defeated. Avoid direct exposure to beam.
3. **CAUTION:** Do not open the top cover. There are no user-serviceable parts inside. Leave all servicing to qualified service personnel.
4. **CAUTION:** This CD player uses invisible laser radiation and is equipped with safety switches to prevent radiation emission when unloading CDs. It is dangerous to defeat the safety switches.
5. **CAUTION:** Use of controls, adjustments or performance of procedures other than those specified herein may result in hazardous radiation exposure.

CLASS 1
LASER PRODUCT

Caution:
This product contains a laser component of higher laser class than Class 1.

How to reset your unit

Press and hold both the SEL (Select) and Φ /I/ATT (Standby/On/ATT) buttons at the same time for several seconds.

This will reset the built-in microcomputer.

NOTES:

- Your preset adjustments — such as preset channels or sound adjustments — will also be erased.
- If a CD is in the unit, it will eject when you reset the unit. Pay attention not to drop the CD.

Φ /I/ATT
(Standby/On/ATT)

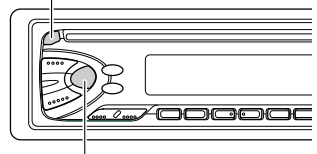

SEL (Select)

Note:

For security reasons, a numbered ID card is provided with this unit, and the same ID number is imprinted on the unit's chassis. Keep the card in a safe place, as it will help the authorities to identify your unit if stolen.

BEFORE USE

* For safety....

- Do not raise the volume level too much, as this will block outside sounds, making driving dangerous.
- Stop the car before performing any complicated operations.

* Temperature inside the car....

If you have parked the car for a long time in hot or cold weather, wait until the temperature in the car becomes normal before operating the unit.

Thank you for purchasing a JVC product. Please read all instructions carefully before operation, to ensure your complete understanding and to obtain the best possible performance from the unit.

CONTENTS

How to reset your unit 2



BASIC OPERATIONS 4

RADIO OPERATIONS 5

Listening to the radio 5

Storing stations in memory 6

FM station automatic preset:SSM 6

Manual preset 7

Tuning into a preset station 8

Other convenient tuner functions 9

Scanning broadcast stations 9

Selecting FM reception sound 9



CD OPERATIONS 10

Playing a CD 10

Locating a track or a particular portion on a CD 11

Selecting CD playback modes 12

Prohibiting CD ejection 12



SOUND ADJUSTMENTS 13

Adjusting the sound 13

Turning on/off the loudness function 14

Using the Sound Control Memory (SCM) 15

Selecting and storing the sound modes 15

Recalling the sound modes 16

Canceling Advanced SCM 17

Storing your own sound adjustments 18



OTHER MAIN FUNCTIONS 19

Setting the clock 19

Selecting the level display 20

Detaching the control panel 21



MAINTENANCE 22

Handling CDs 22

TROUBLESHOOTING 23



SPECIFICATIONS 24



BASIC OPERATIONS

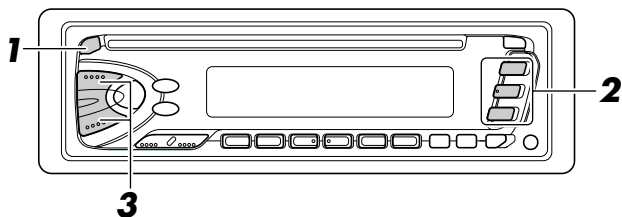

Note:

When you use this unit for the first time, set the built-in clock correctly, see page 19.

1

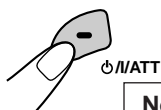

Turn on the power.

Note on One-Touch Operation:

When you select a source in step 2 below, the power automatically comes on. You do not have to press this button to turn on the power.

2

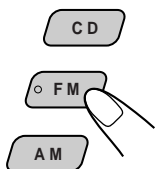

Select the source.

To operate the tuner, see pages 5 – 9.

To operate the CD player, see pages 10 – 12.

3

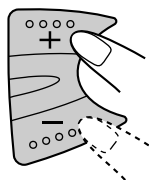

Adjust the volume.



Volume level indicator

Volume level appears

4

Adjust the sound as you want (see pages 13 – 18).

To drop the volume in a moment

Press **⏻/ATT** briefly while listening to any source. “ATT” starts flashing on the display, and the volume level will drop in a moment.

To resume the previous volume level, press the button briefly again.

To turn off the power

Press and hold **⏻/ATT** for more than 1 second.

Listening to the radio

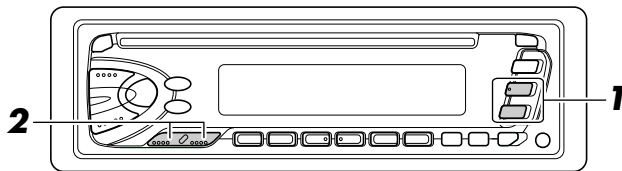

1

Select the band (FM1, FM2, FM3 or AM).

You can select any one of FM1, FM2 and FM3 to listen to an FM station.

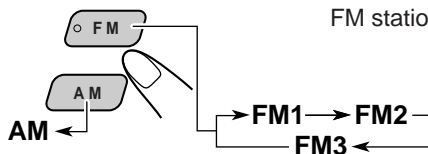

selected band appears



Volume level indicator

2

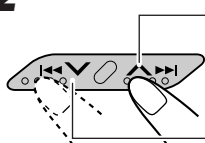

To search stations of higher frequencies.

To search stations of lower frequencies.

Start searching a station.

When a station is received, searching stops.



To stop searching before a station is received, press the same button you have pressed for searching.

To tune in a particular frequency without searching:

1 Select the band (FM or AM).

Press FM or AM.

2 Press and hold \blacktriangle \blacktriangleright or \blacktriangleleft \blacktriangledown until "M" starts flashing on the display.

Now you can manually change the frequency while "M" is flashing.

3 Press \blacktriangle \blacktriangleright or \blacktriangleleft \blacktriangledown repeatedly until the frequency you want is reached.

- If you hold down the button, the frequency keeps changing (in 50 kHz intervals for FM and 9 kHz intervals for AM – MW/LW) until you release the button.



Storing stations in memory

You can use one of the following two methods to store broadcasting stations in memory.

- Automatic preset of FM stations: SSM (Strong-station Sequential Memory)
- Manual preset of both FM and AM stations

FM station automatic preset: SSM

You can preset 6 local FM stations in each FM band (FM1, FM2, and FM3).

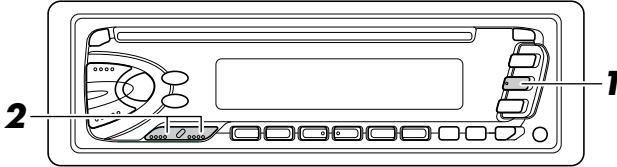

1

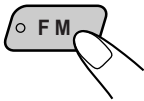

Select the FM band number (FM1, FM2 or FM3) you want to store FM stations into.

2

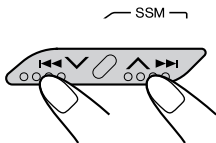

Press and hold the both buttons for more than 2 seconds.

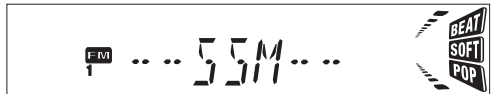

"SSM" appears, then disappears when automatic preset is over

Local FM stations with the strongest signals are searched and stored automatically in the band number you have selected (FM1, FM2 or FM3). These stations are preset in the number buttons — No. 1 (lowest frequency) to No. 6 (highest frequency).

When automatic preset is over, the station stored in number button 1 will be automatically tuned in.

Manual preset

You can preset up to 6 stations in each band (FM1, FM2, FM3 and AM) manually.

EXAMPLE: Storing an FM station of 88.3 MHz into the preset number 1 of the FM1 band

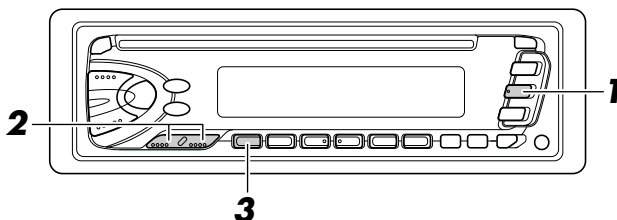
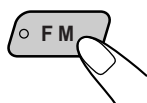

1

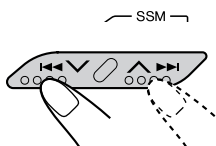
Select the FM1 band.

2

Tune into a station of 88.3 MHz.

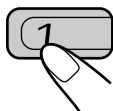
See page 5 to tune into a station.

3

Press and hold the button for more than 2 seconds.



"P1" flashes for a few seconds.

4

Repeat the above procedure to store other stations into other preset numbers.

Notes:

- A previously preset station is erased when a new station is stored in the same preset number.
- Preset stations are erased when the power supply to the memory circuit is interrupted (for example, during battery replacement). If this occurs, preset the stations again.



Tuning into a preset station

You can easily tune into a preset station. Remember that you must store stations first. If you have not stored them yet, see pages 6 and 7.

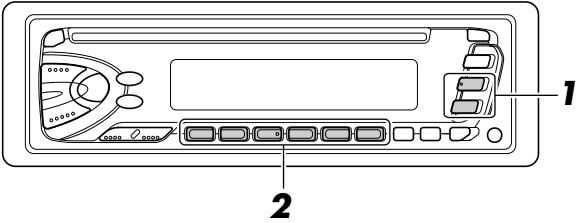

1

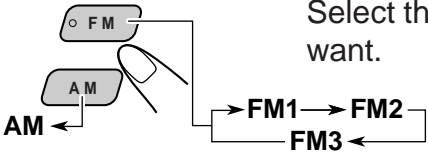

Select the band (FM1, FM2, FM3 or AM) you want.

2

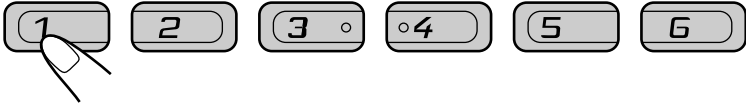

Select the number (1 – 6) for the preset station you want.

Other convenient tuner functions

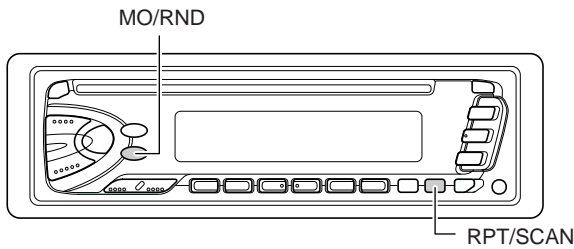

Scanning broadcast stations

When you press RPT/SCAN while listening to the radio, station scanning starts. Each time a broadcast is tuned in, scanning stops for about 5 seconds (tuned frequency number flashes on the display), and you can check what program is now being broadcast.

If you want to listen to that program, press the same button again to stop scanning.

Selecting FM reception sound

When an FM stereo broadcast is hard to receive:

Press MO/RND (Mono/Random) while listening to an FM stereo broadcast. The sound you hear becomes monaural but reception will be improved.

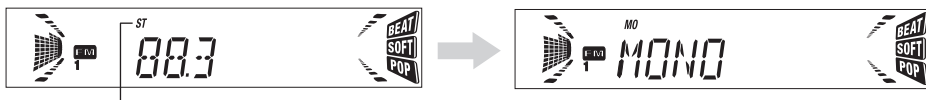

Lights up when receiving an FM broadcast in stereo

To restore the stereo effect, press the same button again.



CD OPERATIONS

Playing a CD

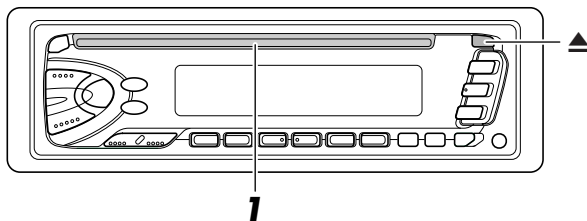

1

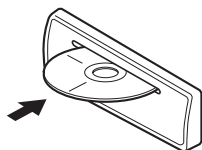

Insert a disc into the loading slot.

The unit turns on, draws a CD and starts playback automatically.

- When a CD is inserted upside down, "EJECT" appears on the display and the CD automatically ejects.

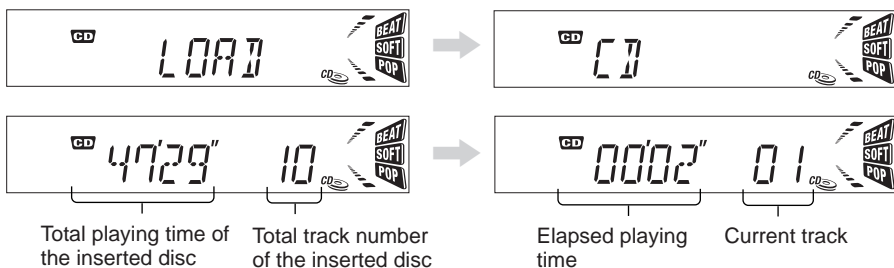

Note on One-Touch Operation:

When a CD is already in the loading slot, pressing CD turns on the unit and starts playback automatically.

CAUTION on Volume Setting

CDs produces very little noise compared with other sources. If the volume level is adjusted for the tuner, for example, the speakers may be damaged by the sudden increase in the output level. Therefore, lower the volume before playing a CD and adjust it as required during playback.

To stop play and eject the CD

Press ▲.

CD play stops and the CD automatically ejects from the loading slot. The source changes to the tuner (you will hear the last received station).

If you change the source to AM or FM, the CD play also stops (without ejecting the CD this time).

- If the ejected disc is not removed for about 15 seconds, the disc is automatically inserted again into the loading slot to protect it from dust. (CD play will not start this time.)
- You can eject the CD even when the unit is turned off.



Locating a track or a particular portion on a CD

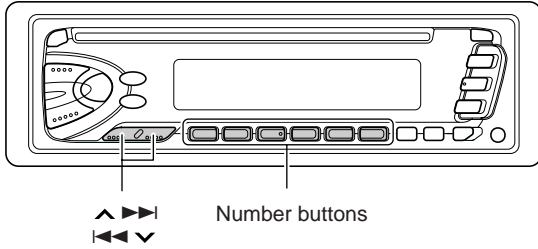

To fast forward or reverse the track

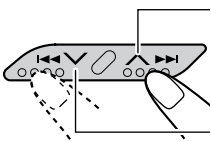

Press and hold **^ >>>|**, while playing a CD, to fast forward the track.

Press and hold **|<<< v**, while playing a CD, to reverse the track.

To go to the next track or the previous track

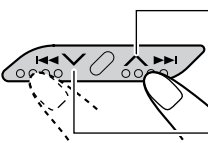

Press **^ >>>|** briefly, while playing a CD, to go ahead to the beginning of the next track. Each time you press the button consecutively, the beginning of the next tracks is located and played back.

Press **|<<< v** briefly, while playing a CD, to go back to the beginning of the current track. Each time you press the button consecutively, the beginning of the previous tracks is located and played back.

To go to a particular track directly

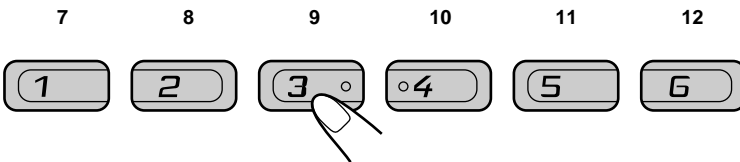

Press the number button corresponding to the track number to start its playback.

- To select a track number from 1 – 6:
Press 1 (7) – 6 (12) briefly.
- To select a track number from 7 – 12:
Press and hold 1 (7) – 6 (12) for more than 1 second.



Selecting CD playback modes

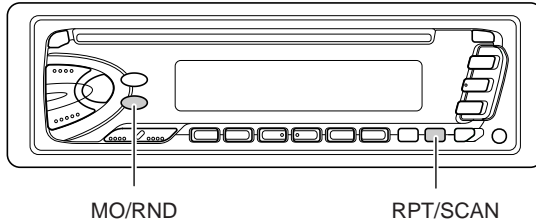

To play back tracks at random (Random Play)

You can play back all tracks on the CD at random.



Each time you press MO/RND (Mono/Random) while playing a CD, CD random play mode turns on and off alternatively.

When the random mode is turned on, the RND indicator lights up on the display and a track randomly selected starts playing.



To play back tracks repeatedly (Repeat Play)

You can play back the current track repeatedly.



Each time you press RPT(Repeat)/SCAN while playing a CD, CD repeat play mode turns on and off alternatively.

When the repeat mode is turned on, the RPT indicator lights up on the display.



Track number of the currently playing track

Prohibiting CD ejection

You can prohibit the CD ejection and can “lock” a CD in the loading slot.

Press and hold CD and ▲ for more than 2 seconds.

“EJECT” flashes on the display for about 5 seconds, and the CD is “locked.”

To cancel the prohibition and “unlock” the CD, press and hold CD and ▲ for more than 2 seconds again. “EJECT” appears on the display, and the CD ejects from the loading slot.



Adjusting the sound

You can adjust the sound characteristics to your preference.

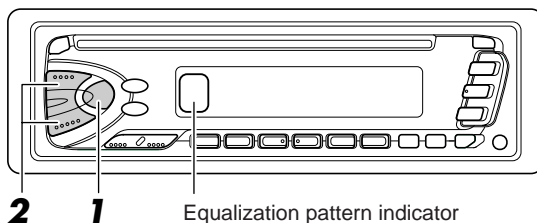

1

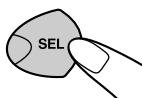

Select the item you want to adjust.

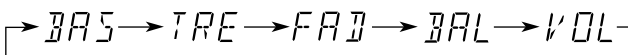

Indication	To do:	Range
BAS (Bass)	Adjust the bass	-06 (min.) — +06 (max.)
TRE (Treble)	Adjust the treble	-06 (min.) — +06 (max.)
FAD (Fader)*	Adjust the front and rear speaker balance	R06 (rear only) — F06 (front only)
BAL (Balance)	Adjust the left and right speaker balance	L06 (left only) — R06 (right only)
VOL (Volume)	Adjust the volume	00 (min.) — 50 (max.)

Note:

* If you are using a two-speaker system, set the fader level to “00”

Adjust the level.

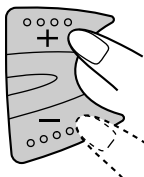

Equalization pattern changes as you adjust the bass or treble

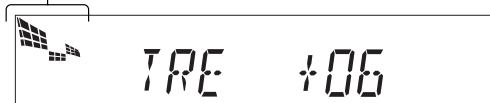

Note:

Normally the + and - buttons work as the volume control buttons. So you do not have to select “VOL” to adjust the volume level.



Turning on/off the loudness function

The human ear is less sensitive to low and high frequencies at low volumes. The loudness function can boost these frequencies to produce a well-balanced sound at low volume levels. Each time you press LOUD, the loudness function turns on/off alternatively.



Using the Sound Control Memory (SCM)

You can select and store a preset sound adjustment suitable to each playback source. (**Advanced SCM**)

Selecting and storing the sound modes

Once you select a sound mode, it is stored in memory, and will be recalled every time you select the same source. A sound mode can be stored each of the following sources — FM1, FM2, FM3, AM and CD.

- If you do not want to store the sound mode separately for each playback source, but want to use the same sound mode for all the sources, see “Canceling Advanced SCM” on page 17.

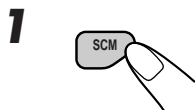
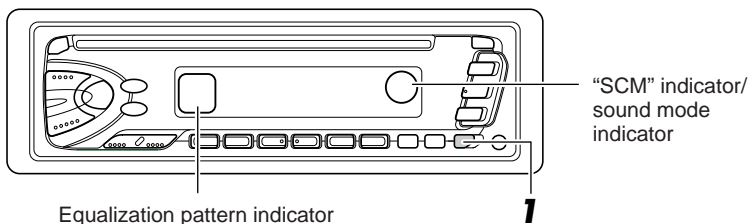

Select the sound mode you want.

Each time you press the button, the sound mode changes as follows.

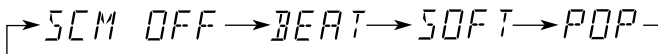

- When “SCM LINK” is set to “LINK ON”, the selected sound mode can be stored in memory for the current source and the effect applies only to the current source. Each time you change the playback source, the SCM indicator flashes on the display.
- When “SCM LINK” is set to “LINK OFF”, the selected sound mode effect applies to any source.

Indication	For:	Preset values		
		Bass	Treble	Loudness
SCM OFF	(Flat sound)	00	00	On
BEAT	Rock or disco music	+02	00	On
SOFT	Quiet background music	+01	-03	Off
POP	Light music	+04	+01	Off



Recalling the sound modes

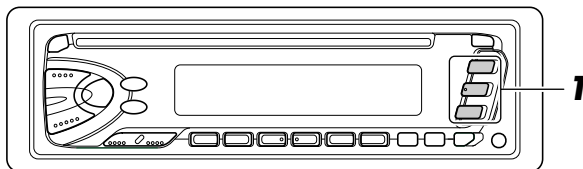

1

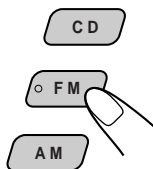

Select the source while the “SCM” indicator is lit on the display.

The “SCM” indicator starts flashing, and the sound mode stored in memory for the selected source is recalled.

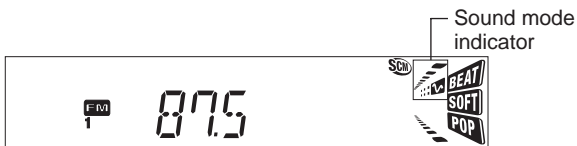

Notes:

- You can adjust each sound mode to your preference, and store it in memory. If you want to adjust and store your original sound mode, see “Storing your own sound adjustments” on page 18.
- To adjust the bass and treble reinforcement levels or to turn on/off the loudness function temporarily, see page 13 and 14. (Your adjustments will be cancelled if another source is selected.)



Canceling Advanced SCM

You can cancel the Advanced SCM (Sound Control Memory), and unlink the sound modes and the playback sources.

When shipped from the factory, a different sound mode can be stored in memory for each source so that you can change the sound modes simply by changing the sources.

LINK ON: Advanced SCM (different SCMs for different sources)

LINK OFF: Conventional SCM (one SCM for all sources)

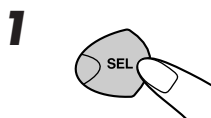
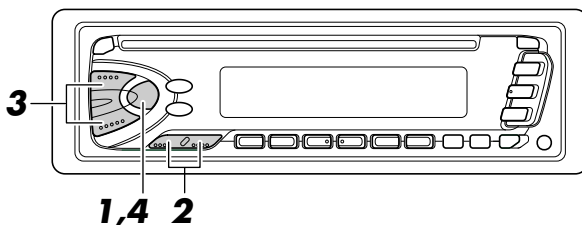

Press and hold SEL for more than 2 seconds. "CLOCK H", "CLOCK M", "SCM LINK" or "LEVEL" appears on the display.

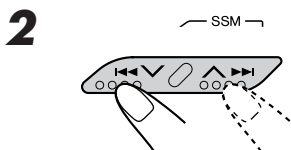

Select "SCM LINK" if not shown on the display.

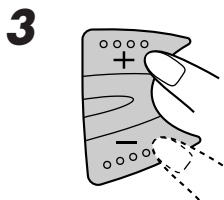

Select the desired mode — "LINK ON" or "LINK OFF".

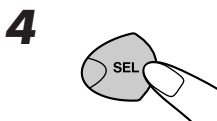

Finish the setting.

Storing your own sound adjustments

You can adjust the sound modes (BEAT, SOFT, POP: see page 15) to your preference and store your own adjustments in memory.

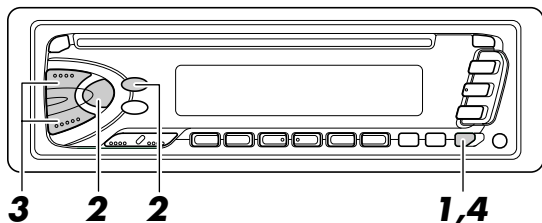
1

Call up the sound mode you want to adjust.
See page 15 for details.

**Within
5 seconds**

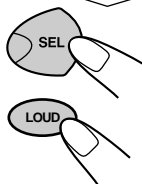
2

To adjust the bass or treble sound level
Select "BAS" or "TRE."

To turn on or off the loudness function

Each time you press LOUD, the loudness function turns on and off alternatively. (→ go to step 4)

**Within
5 seconds**

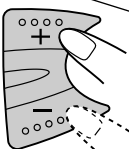
3

Adjust the bass or treble level.

See page 13 for details.

**Within
5 seconds**

4

Press and hold SCM until the sound mode
you have selected in step 1 flashes on the
display.

Your setting is stored in memory.

5

Repeat the same procedure to store other settings.

To reset to the factory settings

Repeat the same procedure and reassign the preset values listed in the table on page 15.

Setting the clock

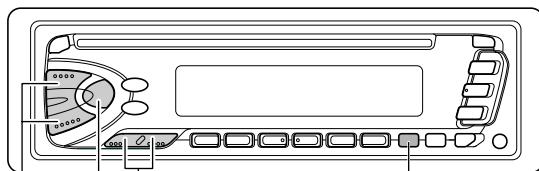

2,3 1,4 2,3

DISP

1

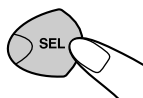

Press and hold SEL for more than 2 seconds.

“CLOCK H”, “CLOCK M”, “SCM LINK” or “LEVEL” appears on the display.

2

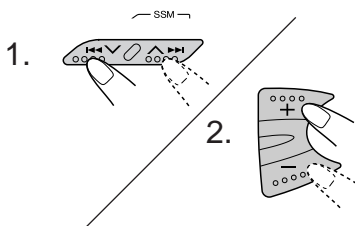

Set the hour.

1. Select “CLOCK H” if not shown on the display.



2. Adjust the hour.

3

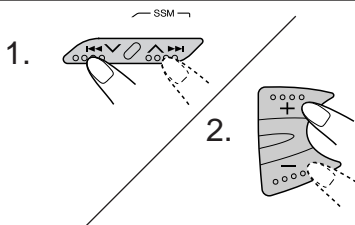

Set the minute.

1. Select “CLOCK M.”



2. Adjust the minute.

4

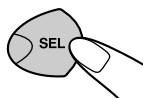

Finish the setting.

To check the current clock time (changing the display mode)

Press DISP repeatedly. Each time you press the button, the display mode changes as follows.

<p>During tuner operation:</p> <p>Clock ↔ Frequency</p>	<p>During CD operation:</p> <p>Clock ↔ Elapsed playing time</p>
--	--

- If the unit is not in use when you press DISP, the power turns on, the clock time is shown for 5 seconds, then the power turns off.

Selecting the level display

You can select the level display according to your preference.
 When shipped from the factory, "VOL 2" is selected.
VOL 1: Shows the volume level indicator and the equalization pattern indicator.
VOL 2: Alternates "VOL 1" setting and illumination display.
OFF: Erase the volume level indicator and the equalization pattern indicator.

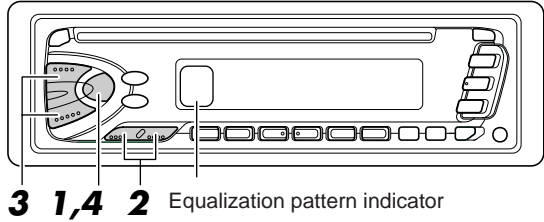



3 1,4 2 Equalization pattern indicator

1  Press and hold SEL for more than 2 seconds. "CLOCK H", "CLOCK M", "SCM LINK" or "LEVEL" appears on the display.

2  Select "LEVEL" if not shown on the display.

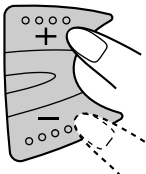

3  Select the desired mode — "VOL 1", "VOL 2" or "OFF".

4  Finish the setting.

Detaching the control panel

You can detach the control panel when leaving the car. When detaching or attaching the control panel, be careful not to damage the connectors on the back of the control panel and on the panel holder.

How to detach the control panel

Before detaching the control panel, be sure to turn off the power.

- 1 Unlock the control panel.

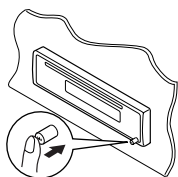

- 2 Lift and pull the control panel out of the unit.

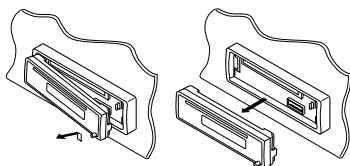

- 3 Put the detached control panel into the case provided.

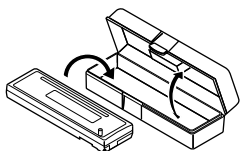

How to attach the control panel

- 1 Insert the left side of the control panel into the groove on the panel holder.

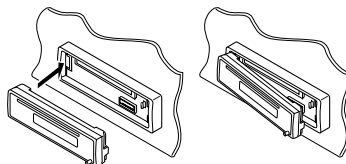

- 2 Press the right side of the control panel to fix it to the panel holder.

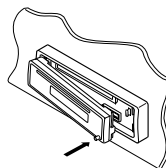

Note on cleaning the connectors:

If you frequently detach the control panel, the connectors will deteriorate.

To minimize this possibility, periodically wipe the connectors with a cotton swab or cloth moistened with alcohol, being careful not to damage the connectors.

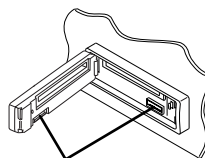

Connectors



MAINTENANCE

Handling CDs

This unit has been designed only to reproduce the CDs bearing the  mark. Other discs cannot be played back.

How to handle CDs

When removing a CD from its case, press down the center holder of the case and lift the CD out, holding it by the edges.

- Always hold the CD by the edges. Do not touch its recording surface.

When storing a CD into its case, gently insert the CD around the center holder (with the printed surface facing up).

- Make sure to store CDs into the cases after use.

To keep CDs clean

A dirty CD may not play correctly. If a CD does become dirty, wipe it with a soft cloth in a straight line from center to edge.

To play new CDs

New CDs may have some rough spots around the inner and outer edges. If such a CD is used, this unit may reject the CD.

To remove these rough spots, rub the edges with a pencil or ball-point pen, etc.

Moisture condensation

Moisture may condense on the lens inside the CD player in the following cases:

- After starting the heater in the car.
- If it becomes very humid inside the car.

Should this occur, the CD player may malfunction. In this case, eject the CD and leave the unit turned on for a few hours until the moisture evaporates.

Center holder



CAUTIONS:

- Do not insert 8cm (3 3/16") CDs (single CDs) into the loading slot. (Such CDs cannot be ejected.)
- Do not insert any CD of unusual shape – like a heart or flower; otherwise, it will cause a malfunction.
- Do not expose CDs to direct sunlight or any heat source or place them in a place subject to high temperature and humidity. Do not leave them in a car.
- Do not use any solvent (for example, conventional record cleaner, spray, thinner, benzine, etc.) to clean CDs.

When playing a CD-R (Recordable)

You can play back your original CD-Rs on this receiver.

- Before playing back CD-Rs, read their instructions or cautions carefully.
- Some CD-Rs recorded on CD recorders may not be played back on this receiver because of their disc characteristics, and of the following reasons:
 - Discs are dirty or scratched.
 - Moisture condensation occurs on the lens inside the unit.
 - The pickup lens inside the CD player is dirty.
- Use only "finalized" CD-Rs.
- CD-RWs (Rewritable) cannot be played back on this receiver.



About mistracking:

Mistracking may result from driving on extremely rough roads. This does not damage the unit and the CD, but will be annoying.

We recommend that you stop CD play while driving on such rough roads.

TROUBLESHOOTING

What appears to be trouble is not always serious. Check the following points before calling a service center.

Symptoms	Causes	Remedies
• CD cannot be played back.	CD is inserted upside down.	Insert the CD correctly.
• CD sound is sometimes interrupted.	You are driving on rough roads.	Stop CD play while driving on rough roads.
	CD is scratched.	Change the CD.
	Connections are incorrect.	Check the cords and connections.
• "NO DISC" appears on the display.	No CD is in the loading slot.	Insert a CD into the loading slot.
	CD is inserted incorrectly.	Insert it correctly.
• Sound cannot be heard from the speakers.	The volume control is turned to the minimum level.	Adjust it to the optimum level.
	Connections are incorrect.	Check the cords and connections.
• SSM (Strong-station Sequential Memory) automatic preset does not work.	Signals are too weak.	Store stations manually.
• Static noise while listening to the radio.	The antenna is not connected firmly.	Connect the antenna firmly.
• CD can be neither played back nor ejected.	The CD player may function incorrectly.	Press  /I/ATT and  at the same time for more than 2 seconds. Be careful not to drop CD when it is ejected.
• The unit does not work at all.	The built-in microcomputer may function incorrectly due to noise, etc.	Press  /I/ATT and SEL at the same time for more than 2 seconds to reset the unit. (The clock setting and preset stations stored in memory are erased.) (See page 2.)



SPECIFICATIONS

AUDIO AMPLIFIER SECTION

Maximum Power Output:

Front: 40 watts per channel

Rear: 40 watts per channel

Continuous Power Output (RMS):

Front: 16 watts per channel into 4 Ω, 40 to 20 000 Hz at no more than 0.8% total harmonic distortion.

Rear: 16 watts per channel into 4 Ω, 40 to 20 000 Hz at no more than 0.8% total harmonic distortion.

Load Impedance: 4 Ω (4 to 8 Ω allowance)

Tone Control Range

Bass: ±10 dB at 100 Hz

Treble: ±10 dB at 10 kHz

Frequency Response: 40 to 20 000 Hz

Signal-to-Noise Ratio: 70 dB

Line-Out Level/Impedance: 2.0 V/20 kΩ load (full-scale)

Output Impedance: 1 kΩ

TUNER SECTION

Frequency Range

FM: 87.5 MHz to 108.0 MHz

AM: (MW) 522 kHz to 1 620 kHz

(LW) 144 kHz to 279 kHz

[FM Tuner]

Usable Sensitivity: 11.3 dBf (1.0 μV/75 Ω)

50 dB Quieting Sensitivity:

16.3 dBf (1.8 μV/75 Ω)

Alternate Channel Selectivity (400 kHz):

65 dB

Frequency Response: 40 to 15 000 Hz

Stereo Separation: 30 dB

Capture Ratio: 1.5 dB

[MW Tuner]

Sensitivity: 20 μV

Selectivity: 35 dB

[LW Tuner]

Sensitivity: 50 μV

CD PLAYER SECTION

Type: Compact disc player

Signal Detection System: Non-contact optical pickup (semiconductor laser)

Number of channels: 2 channels (stereo)

Frequency Response: 5 to 20 000 Hz

Dynamic Range: 96 dB

Signal-to-Noise Ratio: 98 dB

Wow and Flutter: Less than measurable limit

GENERAL

Power Requirement

Operating Voltage: DC 14.4 volts (11 to 16 volts allowance)

Allowable Working Temperature:

0°C to +40°C

Grounding System: Negative ground

Dimensions (W x H x D)

Installation Size:

182 x 52 x 150 mm

Panel Size: 188 x 58 x 14 mm

Mass: 1.3 kg (excluding accessories)

Design and specifications subject to change without notice.

**Having TROUBLE with operation?
Please reset your unit**

Refer to page of How to reset your unit

**Haben Sie PROBLEME mit dem Betrieb?
Bitte setzen Sie Ihr Gerät zurück**

Siehe Seite Zurücksetzen des Geräts

**Vous avez des PROBLÈMES de fonctionnement?
Réinitialisez votre appareil**

Référez-vous à la page intitulée Comment réinitialiser votre appareil

**Hebt u PROBLEMEN met de bediening?
Stel het apparaat terug**

Zie de pagina met de paragraaf Het apparaat terugstellen

JVC

VICTOR COMPANY OF JAPAN, LIMITED

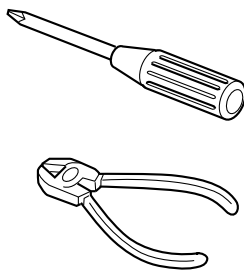

ENGLISH

- This unit is designed to operate only on 12 volts DC, NEGATIVE ground electrical systems.

INSTALLATION (IN-DASH MOUNTING)

- The following illustration shows a typical installation. However, you should make adjustments corresponding to your specific car. If you have any questions or require information regarding installation kits, consult your JVC IN-CAR ENTERTAINMENT dealer or a company supplying kits.

DEUTSCH

- Dieses Gerät ist nur für einen Betrieb in elektrischen Anlagen mit 12 V Gleichstrom und (-) Erdung ausgelegt.

EINBAU (IM ARMATURENBRETT)

- Die folgende Abbildung zeigt einen typischen Einbau. Dennoch müssen Sie entsprechend Ihrem jeweiligen Auto Anpassungen vornehmen. Bei irgendwelchen Fragen oder wenn Sie Informationen hinsichtlich des Einbausatzes brauchen, wenden Sie sich an ihren JVC Autoradiohändler oder ein Unternehmen das diese Einbausätze vertreibt.

FRANÇAIS

- Cet appareil est conçu pour fonctionner sur des sources de courant continu de 12 volts à masse NEGATIVE seulement.

INSTALLATION (MONTAGE DANS LE TABLEAU DE BORD)

- L'illustration suivante est un exemple d'installation typique. Cependant, vous devez faire les ajustements correspondant à votre voiture particulière. Si vous avez des questions ou avez besoin d'information sur des kits d'installation, consulter votre revendeur d'autoradios JVC ou une compagnie d'approvisionnement.

1 Before mounting: Press (Control Panel Release) to detach the control panel if already attached.

* When shipped from the factory, the control panel is packed in the hard case.

2 Remove the trim plate.

3 Remove the sleeve after disengaging the sleeve locks.

① Stand the unit.

Note: When you stand the unit, be careful not to damage the fuse on the rear.

② Insert the 2 handles between the unit and the sleeve, as illustrated, to disengage the sleeve locks.

③ Remove the sleeve.

Note: Be sure to keep the handles for future use after installing the unit.

4 Install the sleeve into the dashboard.

* After the sleeve is correctly installed in the dashboard, bend the appropriate tabs to hold the sleeve firmly in place, as illustrated.

5 Fix the mounting bolt to the rear of the unit's body and place the rubber cushion over the end of the bolt.

6 Do the required electrical connections.

7 Slide the unit into the sleeve until it is locked.

8 Attach the trim plate so that the projection on the trim plate is fixed to the left side of the unit.

9 Attach the control panel.

1 Vor dem Einbau: Drücken Sie (Freigabe der Bedienungsblende), um die Arretierung der Bedienungsblende zu lösen, sofern diese bereits angebracht ist.

* Bei der Auslieferung ab Werk ist die Bedienungsblende im Etui verpackt.

2 Den Frontrahmen herausnehmen.

3 Die Halterung nach dem Entriegeln der Halterungssperren abnehmen.

① Das Gerät aufstellen.

Hinweis: Beim Aufstellen des Geräts darauf achten, daß die Sicherung auf der Rückseite nicht beschädigt wird.

② Die beiden Griffe zwischen dem Gerät und der Halterung wie abgebildet einstecken und die Halterungssperren entriegeln.

③ Die Halterung entfernen.

Hinweis: Sicherstellen, daß die Griffe für künftigen Gebrauch nach dem Einbau des Geräts aufbewahrt werden.

4 Die Halterung im Armaturenbrett einbauen.

* Nach dem korrekten Einbau der Halterung im Armaturenbrett, die entsprechenden Riegel umknicken, um die Halterung an ihrem Platz zu sichern, siehe Abbildung.

5 Die Befestigungsschraube an der Rückseite des Gerätekörpers befestigen und das Ende der Schraube mit einem Gummipuffer abdecken.

6 Nehmen Sie die erforderlichen elektrischen Anschlüsse vor.

7 Das Gerät in die Halterung schieben, bis es einrastet.

8 Befestigen Sie die Frontrahmen in der Form, daß der Fortsatz der Frontrahmen auf der linken Seite des Geräts befestigt wird.

9 Die Schalttafel anbringen.

1 Avant le montage: Appuyez sur (déblocage du panneau de commande) pour éventuellement détacher le panneau de commande.

* Lorsque ce panneau de commande sort d'usine, il est rangé dans un étui de transport.

2 Retirer la plaque d'assemblage.

3 Libérer les verrous du manchon et retirer le manchon.

① Poser l'appareil à la verticale.

Remarque: Lorsque vous mettez l'appareil à la verticale, faire attention de ne pas endommager le fusible situé sur le fond.

② Insérer les 2 poignées entre l'appareil et le manchon comme indiqué pour désengager les verrous de manchon.

③ Retirer le manchon.

Remarque: S'assurer de garder les poignées pour une utilisation ultérieure, après l'installation de l'appareil.

4 Installer le manchon dans le tableau de bord.

* Après installation correcte du manchon dans le tableau de bord, plier les bonnes pattes pour maintenir fermement le manchon en place, comme montré.

5 Monter le boulon de montage sur l'arrière du corps de l'appareil puis passer l'amortisseur en caoutchouc sur l'extrémité du boulon.

6 Réalisez les connexions électriques.

7 Faire glisser l'appareil dans le manchon jusqu'à ce qu'il soit verrouillé.

8 Attachez la plaque d'assemblage de façon que la projection de la plaque soit fixée sur le côté gauche de l'appareil.

9 Remonter le panneau de commande.

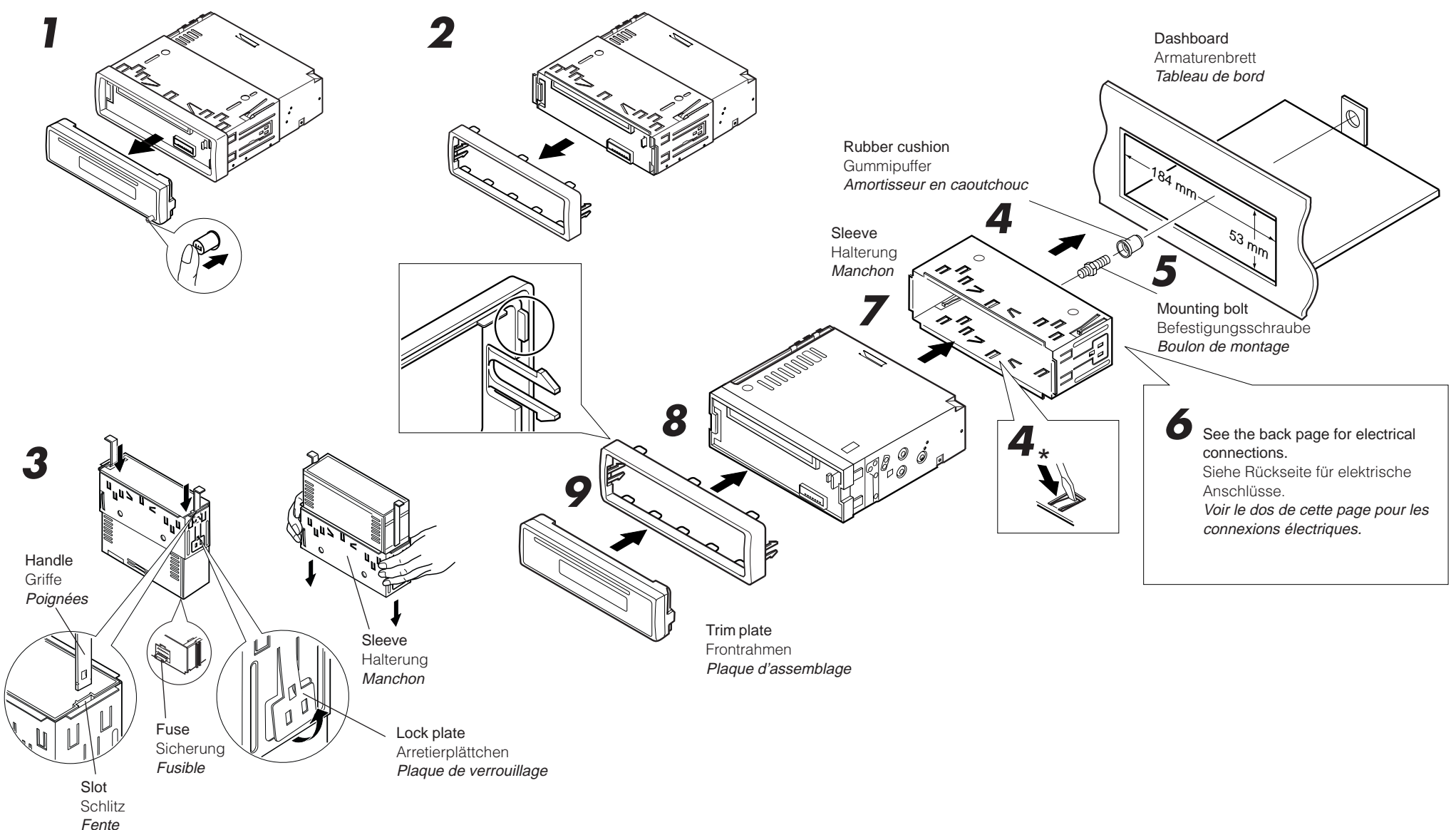

- When using the optional stay
- Beim Verwenden der Anker-Option
- Lors de l'utilisation du hauban en option

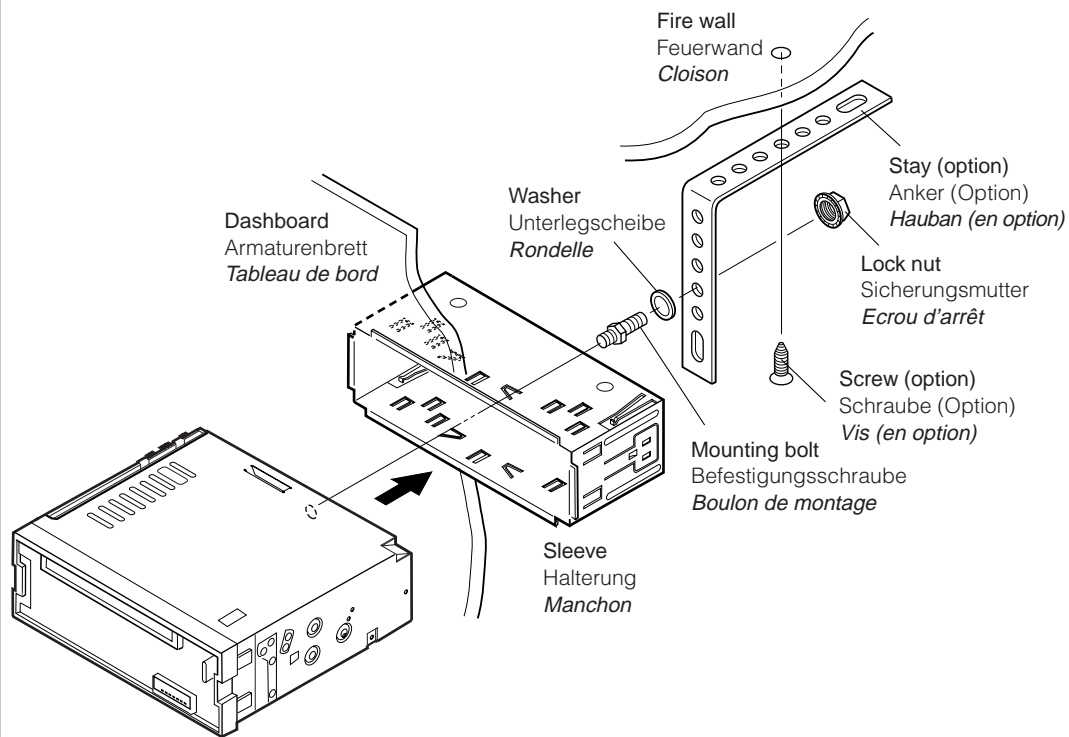

- When installing the unit without using the sleeve
- Beim Einbau des Geräts ohne Halterung
- Lors de l'installation de l'appareil sans utiliser de manchon

In a Toyota for example, first remove the car radio and install the unit in its place.
Zum Beispiel in einem Toyota zuerst das Autoradio ausbauen und dann das Gerät an seinem Platz einbauen.
Par exemple dans une Toyota, retirer d'abord l'autoradio et installer l'appareil à la place.

Flat type screws (M5 x 6 mm)*
Senkkopfschrauben (M5 x 6 mm)*
Vis à tête plate (M5 x 6 mm)*

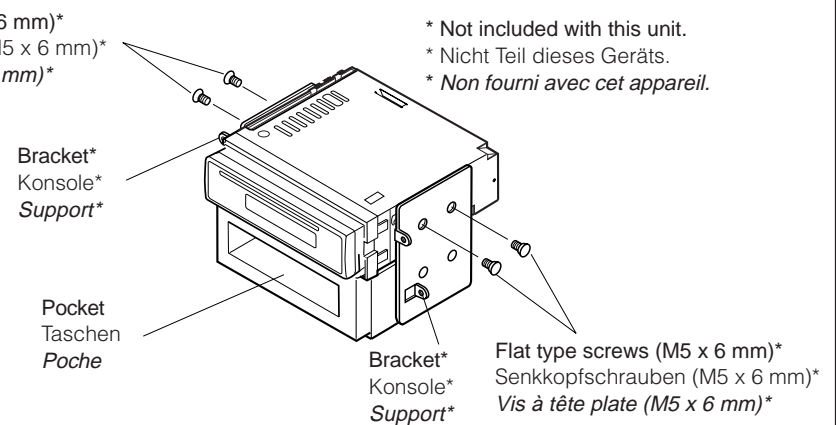

* Not included with this unit.
* Nicht Teil dieses Geräts.
* Non fourni avec cet appareil.

Nota: When installing the unit on the mounting bracket, make sure to use the 6 mm-long screws. If longer screws are used, they could damage the unit.

Hinweis: Beim Anbringen des Gerät an der Konsole sicherstellen, daß 6 mm lange Schrauben verwendet werden. Werden längere Schrauben verwendet, können sie das Gerät beschädigen.

Remarque: Lors de l'installation de l'appareil sur le support de montage, s'assurer d'utiliser des vis d'une longueur de 6 mm. Si des vis plus longues sont utilisées, elles peuvent endommager l'appareil.

Removing the unit

- Before removing the unit, release the rear section.

- 1 Remove the control panel.
- 2 Remove the trim plate.
- 3 Insert the 2 handles into the slots, as shown. Then, while gently pulling the handles away from each other, slide out the unit. (Be sure to keep the handles after installing it.)

Ausbau des Geräts

- Vor dem Ausbau des Geräts den hinteren Teil freigeben.

- 1 Die Schalttafel abnehmen.
- 2 Den Frontrahmen abnehmen.
- 3 Die 2 Griffe in die Schlitze wie gezeigt stecken. Dann die Griffe behutsam auseinander ziehen und das Gerät herausziehen. (Die Griffe nach dem Einbau auf jeden Fall aufbewahren.)

Retrait de l'appareil

- Avant de retirer l'appareil, libérer la section arrière.

- 1 Retirer le panneau de commande.
- 2 Retirer la plaque d'assemblage.
- 3 Introduire les deux poignées dans les fentes, comme montré. Puis, tout en tirant doucement les poignées écartées, faire glisser l'appareil pour le sortir. (S'assurer de conserver les poignées après l'installation de l'appareil.)

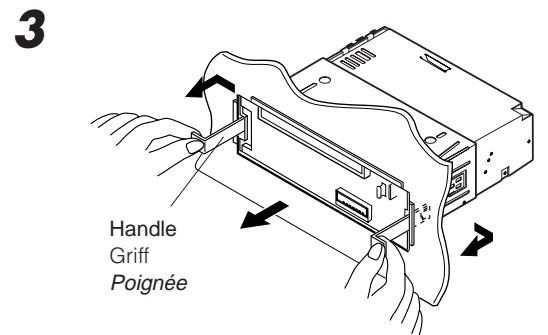
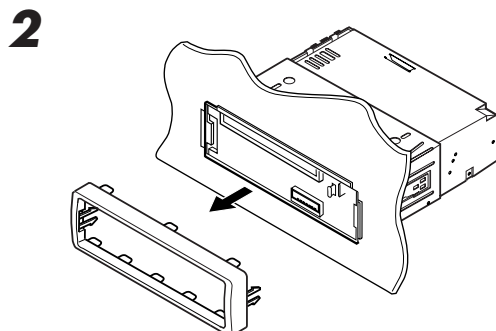
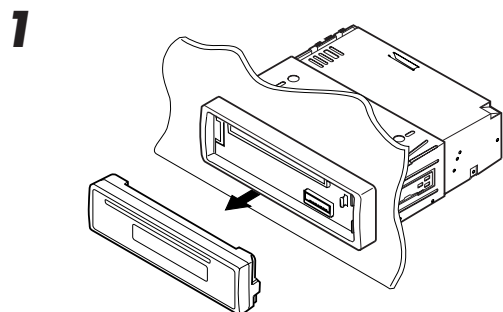

Parts list for installation and connection

The following parts are provided with this unit.
After checking them, please set them correctly.

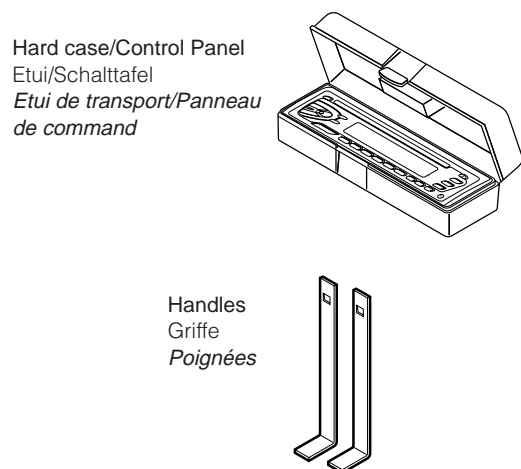

Trim plate
Frontrahmen
Plaque d'assemblage

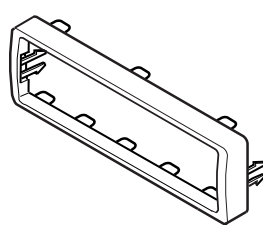

Sleeve
Halterung
Manchon

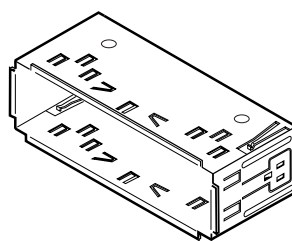

Power cord
Spannungsversorgungskabel
Cordon d'alimentation

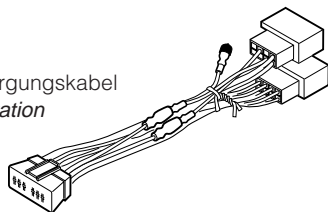

Liste des pièces pour l'installation et raccordement

Les pièces suivantes sont fournies avec cet appareil.
Après vérification, veuillez les placer correctement.

Rubber cushion
Gummipuffer
Amortisseur en caoutchouc



Lock nut (M5)
Sicherungsmutter (M5)
Ecrou d'arrêt (M5)



Mounting bolt (M5 x 20 mm)
Befestigungsschrauben (M5 x 20 mm)
Boulon de montage (M5 x 20 mm)



Washer (ø5)
Unterlegscheibe (ø5)
Rondelle (ø5)



TROUBLESHOOTING

- **The fuse blows.**
* Are the red and black leads connected correctly?
- **Power cannot be turned on.**
* Is the yellow lead connected?
- **No sound from the speakers.**
* Is the speaker output lead short-circuited?
- **Sound is distorted.**
* Is the speaker output lead grounded?
* Are the "-" terminals of L and R speakers grounded in common?
- **Unit becomes hot.**
* Is the speaker output lead grounded?
* Are the "-" terminals of L and R speakers grounded in common?

FEHLERSUCHE

- **Die Sicherung brennt durch.**
* Sind die roten und schwarzen Leitungen richtig angeschlossen?
- **Stromversorgung kann nicht eingeschaltet werden.**
* Ist die gelbe Leitung angeschlossen?
- **Kein Ton aus den Lautsprechern.**
* Ist die Lautsprecherausgangsleitung kurzgeschlossen?
- **Ton verzerrt.**
* Ist die Lautsprecherausgangsleitung geerdet?
* Sind die (-) Anschlußklemmen der linken und rechten Lautsprecher zusammen geerdet?
- **Gerät wird heiß.**
* Ist die Lautsprecherausgangsleitung geerdet?
* Sind die (-) Anschlußklemmen der linken und rechten Lautsprecher zusammen geerdet?

EN CAS DE DIFFICULTÉS

- **Le fusible saute.**
* Les fils rouge et noir sont-ils raccordés correctement?
- **L'appareil ne peut pas être mise sous tension.**
* Le fil jaune est-elle raccordée?
- **Pas de son des haut-parleurs.**
* Le fil de sortie de haut-parleur est-il court-circuité?
- **Le son est déformé.**
* Le fil de sortie de haut-parleur est-il à la masse?
* Les bornes "-" des haut-parleurs gauche et droit sont-elles mises ensemble à la masse?
- **L'appareil devient chaud.**
* Le fil de sortie de haut-parleur est-il à la masse?
* Les bornes "-" des haut-parleurs gauche et droit sont-elles mises ensemble à la masse?

ELECTRICAL CONNECTIONS

To prevent short circuits, we recommend that you disconnect the battery's negative terminal and make all electrical connections before installing the unit. If you are not sure how to install this unit correctly, have it installed by a qualified technician.

Note:

This unit is designed to operate only on **12 volts DC, NEGATIVE ground electrical systems**. If your vehicle does not have this system, a voltage inverter is required, which can be purchased at JVC IN-CAR ENTERTAINMENT dealers.

- Replace the fuse with one of the specified rating. If the fuse blows frequently, consult your JVC IN-CAR ENTERTAINMENT dealer.
- If noise is a problem...
This unit incorporates a noise filter in the power circuit. However, with some vehicles, clicking or other unwanted noise may occur. If this happens, connect the unit's **rear ground terminal** (See connection diagram below.) to the car's chassis using shorter and thicker cords, such as copper braiding or gauge wire. If noise still persists, consult your JVC IN-CAR ENTERTAINMENT dealer.
- Maximum input of the speakers should be more than 40 watts at the rear and 40 watts at the front, with an impedance of **4 to 8 ohms**.
- **Be sure to ground this unit to the car's chassis.**
- The heat sink becomes very hot after use. Be careful not to touch it when removing this unit.

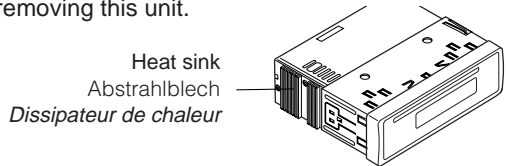

ELEKTRISCHE ANSCHLÜSSE

Zur Vermeidung von Kurzschlüssen empfehlen wir, daß Sie den negativen Batterieanschluß abtrennen und alle elektrischen Anschlüsse herstellen, bevor das Gerät eingebaut wird. Sind Sie sich über den richtigen Einbau des Geräts nicht sicher, lassen Sie es von einem qualifizierten Techniker einbauen.

Hinweis:

Dieses Gerät ist für den Betrieb in **elektrischen Anlagen mit 12 V Gleichstrom und (-) Erdung** ausgelegt. Verfügt Ihr Fahrzeug nicht über diese Anlage, ist ein Spannungsinverter erforderlich, der bei JVC Auto rad iohändler erworben werden kann.

- Die Sicherung mit einer der entsprechenden Nennleistung ersetzen. Brennt die Sicherung häufig durch, wenden Sie sich an ihren JVC Autoradiohändler.
- Sind Störgeräusche ein Problem...
Dieses Gerät enthält ein Störfilter im Stromkreis. Bei manchen Fahrzeugen kann jedoch ein Klicken oder andere unerwünschte Störgeräusche auftreten. Sollte das der Fall sein, die **hintere Erdungsanschlußklemme** (siehe Schaltplan unten) des Geräts am Fahrwerk des Fahrzeugs anschließen, dabei kürzere und dickere Kabel wie beispielsweise Kupfergeflechtdraht oder Stahldraht verwenden. Bleibt Störgeräusch bestehen, wenden Sie sich an Ihren JVC Autoradiohändler.
- Maximale Eingangsleistung der Lautsprecher muß höher als 40 W hinten und 40 W vorne sein, mit einer Impedanz von **4 bis 8 Ohm**.
- **Sicherstellen, daß das Gerät am Fahrwerk geerdet wird.**
- Das Abstrahlblech wird nach dem Gebrauch sehr heiß. Beim Ausbau des Geräts darauf achten, das Abstrahlblech nicht zu berühren.

RACCORDEMENTS ELECTRIQUES

Pour éviter tout court-circuit, nous vous recommandons de débrancher la borne négative de la batterie et d'effectuer tous les raccordements électriques avant d'installer l'appareil. Si l'on n'est pas sûr de pouvoir installer correctement cet appareil, le faire installer par un technicien qualifié.

Remarque:

Cet appareil est conçu pour fonctionner sur des sources de courant continu de **12 volts à masse NEGATIVE** seulement. Si votre véhicule n'offre pas ce type d'alimentation, il vous faut un convertisseur de tension, que vous pouvez acheter chez un revendeur d'autoradios JVC.

- Remplacer le fusible par un de la valeur précisée. Si le fusible saute souvent, consulter votre revendeur d'autoradios JVC.
- Si le bruit est un problème...
Cet appareil incorpore un filtre de bruit dans le circuit d'alimentation. Cependant, avec certains véhicules, quelques claquements ou autres bruits non désirés risquent de se produire. Si cela arrive, raccorder la borne de masse arrière de l'appareil au châssis de la voiture (voir le schéma de raccordement ci-dessous) en utilisant des cordons les plus gros et les plus courts possibles telle qu'une barre de cuivre ou une tresse. Si le bruit persiste, consulter votre revendeur d'autoradios JVC.
- La puissance admissible des haut-parleurs doit être supérieure à 40 watts à l'arrière et à 40 watts l'avant, avec une impédance de **4 à 8 ohms**.
- **S'assurer de raccorder la mise à la masse de cet appareil au châssis de la voiture.**
- Le radiateur devient très chaud après usage. Faire attention de ne pas le toucher en retirant cet appareil.

A If your car is equipped with the ISO connector
Wenn Ihr Auto mit ISO-Steckern ausgestattet ist
Si votre voiture est équipée d'un connecteur ISO

- Connect the ISO connectors as illustrated.
- Die ISO-Stecker wie abgebildet anschließen.
- Connectez les connecteurs ISO comme montré sur l'illustration.

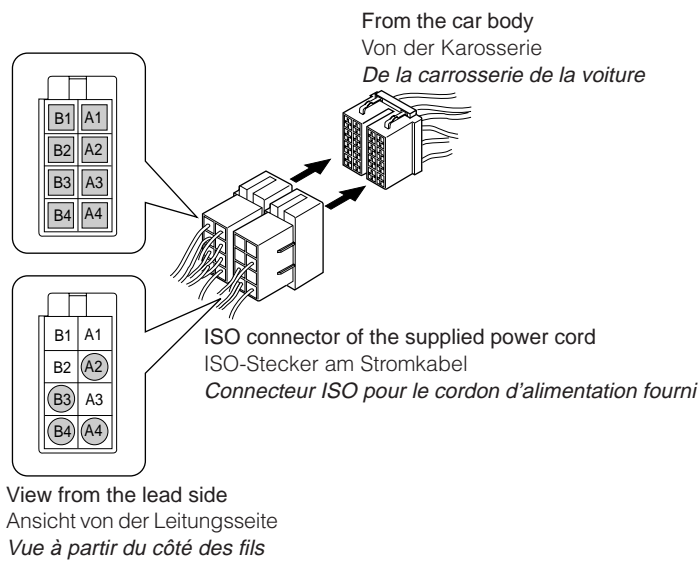

For some VW/Audi or Opel (Vauxhall) automobile
Für manche VW/Audi oder Opel (Vauxhall) Fahrzeuge
Pour certaine voiture VW/Audi ou Opel (Vauxhall)

You may need to modify the wiring of the supplied power cord as illustrated.

- Contact your authorized car dealer before installing this unit.
- Sie müssen evtl. die Verdrahtung des mitgelieferten Stromkabels wie abgebildet ändern.
- Wenden Sie sich an Ihre Vertragswerkstatt, bevor Sie das Gerät einbauen.
- Vous aurez peut-être besoin de modifier le câblage du cordon d'alimentation fourni comme montré sur l'illustration.
- Contactez votre revendeur automobile autorisé avant d'installer l'appareil.

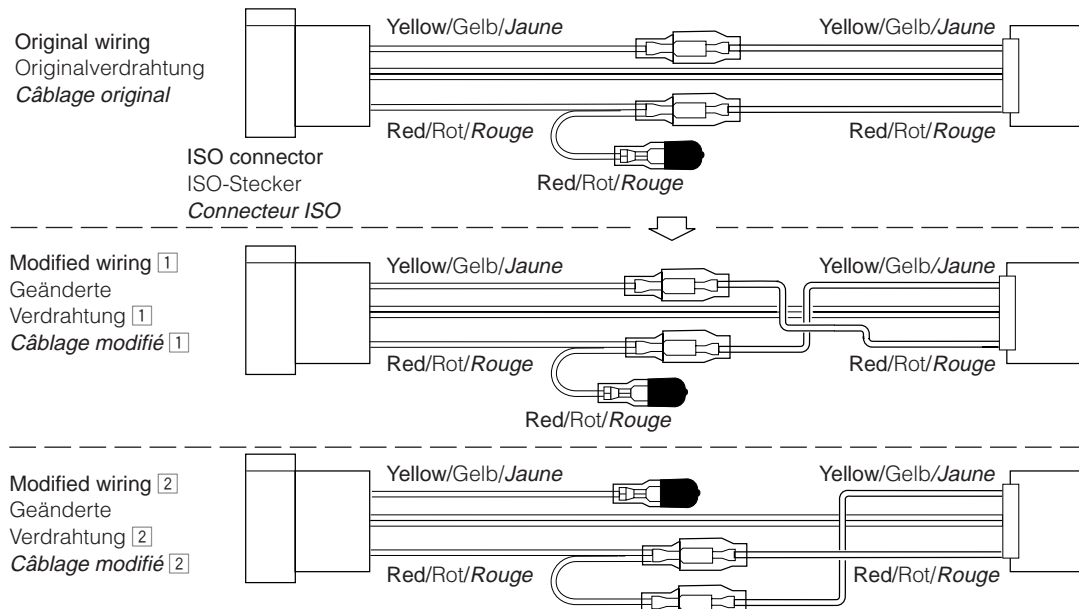

Use modified wiring [2] if the unit does not turn on. Geänderte Verdrahtung [2] verwenden, wenn das Gerät so nicht an geht. Utilisez le câblage modifié [2] si l'appareil ne se met pas sous tension.

PRECAUTIONS on power supply and speaker connections:

- **DO NOT connect the speaker leads of the power cord to the car battery; otherwise, the unit will be seriously damaged.**
- Connect the black lead (ground), yellow lead (to car battery, constant 12V), and red lead (to an accessory terminal) correctly.
- BEFORE connecting the speaker leads of the power cord to the speakers, check the speaker wiring in your car.
– If the speaker wiring in your car is as illustrated in Fig. 1 and Fig. 2 below, DO NOT connect the unit using that original speaker wiring. If you do, the unit will be seriously damaged. Redo the speaker wiring so that you can connect the unit to the speakers as illustrated in Fig. 3.
- If the speaker wiring in your car is as illustrated in Fig. 3, you can connect the unit using the original speaker wiring in your car.
- If you are not sure of the speaker wiring of your car, consult your car dealer.

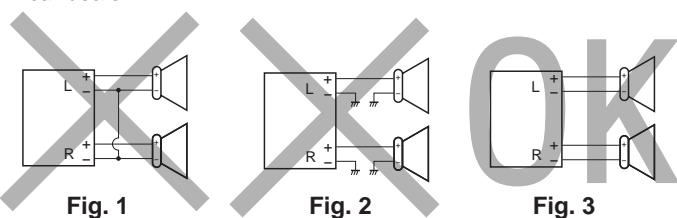

VORSICHTSMASSREGELN beim Anschließen der Stromversorgung und Lautsprecher:

- Die Lautsprecherleitungen des Netzkabels NICHT an der Autobatterie anschließen, da sonst das Gerät schwer beschädigt wird.
- Die schwarze Leitung (Erdung), die gelbe Leitung (zur Autobatterie, konstant 12 V) und die rote Leitung (zur Zubehöranschlußklemme) richtig anschließen.
- VOR dem Anschließen der Lautsprecherleitungen des Spannungsversorgungskabels an die Lautsprecher, die Lautsprecherverdrahtung in Ihrem Auto überprüfen.
– Ist die Lautsprecherverdrahtung wie unten in Fig. 1 und 2 abgebildet, das Gerät NICHT mit der Originalverdrahtung der Lautsprecher anschließen, da sonst das Gerät schwer beschädigt wird. Die Lautsprecherverdrahtung erneuern, so daß Sie das Gerät an den Lautsprechern wie in Fig. 3 abgebildet anschließen können.
- Ist die Lautsprecherverdrahtung in Ihrem Auto wie in Fig. 3 abgebildet, können Sie das Gerät mit der Originalverdrahtung der Lautsprecher in Ihrem Auto anschließen.
- Sind Sie sich über die Lautsprecherverdrahtung in Ihrem Auto nicht sicher, wenden Sie sich an Ihren Autohändler.

PRECAUTIONS sur l'alimentation et la connexion des enceintes:

- **NE CONNECTEZ PAS les fils d'enceintes du cordon d'alimentation à la batterie; sinon, l'appareil serait sérieusement endommagé.**
- Connectez correctement le fil noir (à la masse), le fil jaune (à la batterie de la voiture, 12V constant) et le fil rouge (à la prise accessoire).
- AVANT de connecter les fils d'enceintes du cordon d'alimentation aux enceintes, vérifiez le câblage des enceintes de votre voiture.
– Si le câblage des enceintes de votre voiture est réalisé comme montré sur la Fig. 1 ou Fig. 2 ci-dessous, NE CONNECTEZ PAS l'appareil en utilisant ce câblage original d'enceintes. Si vous le faites, l'appareil sera sérieusement endommagé. Recommencez le câblage des enceintes de façon que vous puissiez connecter l'appareil aux enceintes comme montré sur la Fig. 3.
- Si le câblage des enceintes de votre voiture est comme montré sur la Fig. 3, vous pouvez connecter l'appareil en utilisant ce câblage original d'enceintes pour votre voiture.
- Si vous n'êtes pas sûrs du câblage d'enceintes de votre voiture, consulter le concessionnaire de votre voiture.

Connecting the leads / Anschließen der Leitungen / Raccordement des fils

Twist the core wires when connecting. Die Kerndrähte beim Anschließen verdrehen. Torsader les âmes des fils en les raccordant.

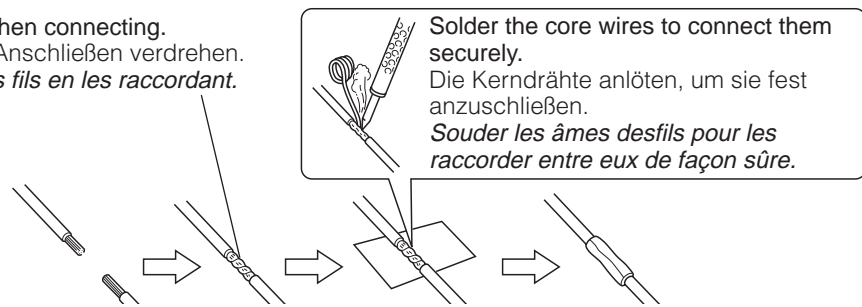

CAUTION / VORSICHT/ PRECAUTION:

- To prevent short-circuit, cover the terminals of the UNUSED leads with insulating tape.
- Zur Vermeidung eines Kurzschlusses die Anschlußklemmen der NICHT VERWENDETEN Leitungen mit Isolierklebeband umwickeln.
- Pour éviter les court-circuits, couvrir les bornes des fils qui ne sont PAS utilisés avec de la bande isolante

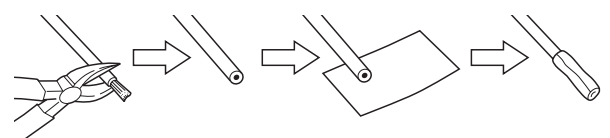

B Connections without using the ISO connectors / Anschlüsse ohne ISO-Stecker / Connexions sans l'utilisation des connecteurs ISO

Before connecting: Check the wiring in the vehicle carefully not to fail in connecting this unit. Incorrect connection may cause a serious damage to this unit.

1 Cut the ISO connector.

2 Connect the colored leads of the power cord to the car battery, speakers and power aerial (if any) in the following sequence.

- ① Black: ground
- ② Yellow: to car battery (constant 12V)
- ③ Red: to an accessory terminal
- ④ Blue with white stripe: to power aerial (200mA max.)
- ⑤ Others: to speakers

3 Connect the antenna cord.

4 Finally connect the wiring harness to the unit.

Vor dem Anschließen: Die Verdrahtung im Fahrzeug sorgfältig überprüfen, damit sie beim Anschließen am Gerät nicht versagt. Falsche Anschlüsse können ernsthafte Schäden am Gerät hervorrufen.

1 Den ISO-Stecker abschneiden.

2 Die farbigen Leitungen des Spannungsversorgungskabels an der Autobatterie, den Lautsprechern und dem Motorantenne (sofern vorhanden) in folgender Reihenfolge anschließen.

- ① Schwarz: Erdung
- ② Gelb: an autobatterie (konstant 12 V)
- ③ Rot: an Zubehöransteckstelle
- ④ Blau mit weißem Streifen: an Motorantenne (200mA maximale)
- ⑤ Andere: an Lautsprecher

3 Das Antennenkabel anschließen.

4 Die Kabelbäume am Gerät anschließen.

Avant de commencer la connexion: vérifiez attentivement le câblage du véhicule pour ne pas connecter incorrectement cet appareil. Une connexion incorrecte peut endommager sérieusement l'appareil.

1 Coupez le connecteur ISO.

2 Connectez les fils de couleur du cordon d'alimentation à la batterie de la voiture, aux enceintes et à l'antenne automatique (s'il y en a une) dans l'ordre suivant.

- ① Noir: a la masse
- ② Jaune: a la batterie de la voiture (12V constant)
- ③ Rouge: à la prise accessoire
- ④ Bleu à bandes blanches: à l'antenne automatique (200mA maximum)
- ⑤ Autres: aux enceintes

3 Connectez le cordon d'antenne.

4 Finalement, connectez le faisceau de fils à l'appareil.

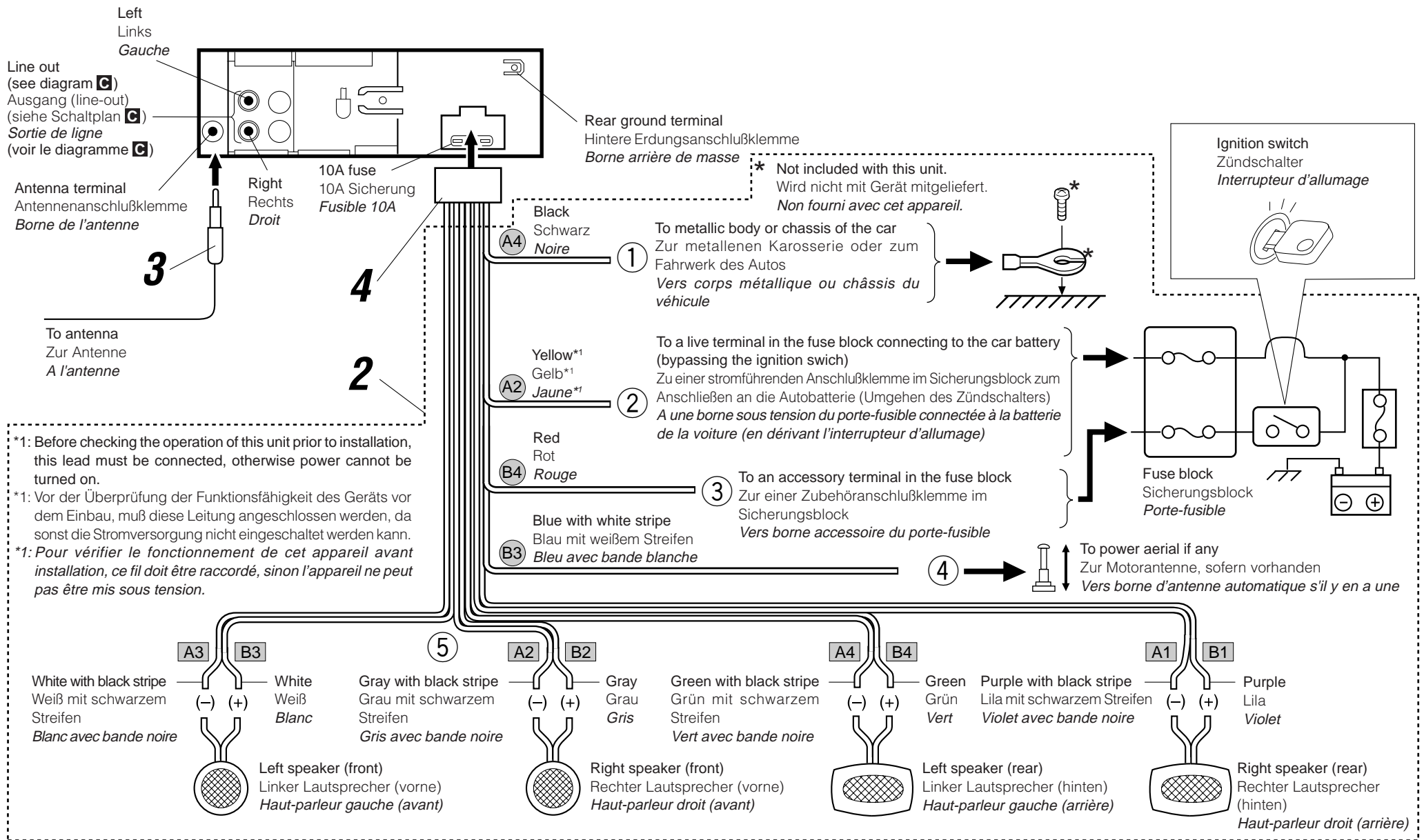

C Connections Adding Other Equipment / Anschlüsse zum Hinzufügen von anderer Ausrüstung / Raccordement pour ajouter d'autres appareils

Since this unit has line-out terminals, an amplifier and other equipment can be used to upgrade your car stereo system.

- Connect the remote lead (blue with white stripe) to the remote lead of the other equipment so that it can be controlled through this unit.
- For amplifier only: Connect this unit's line-out terminals to the amplifier's line-in terminals.

Da dieses Gerät Anschlußklemmen am Ausgang (line-out) hat, können ein Verstärker und andere Ausrüstung zur Aufwertung Ihrer Autostereoanlage verwendet werden.

- Schließen Sie das Fernbedienungskabel (blau mit weißem Streifen) an das Fernbedienungskabel des anderen Geräts an, so daß es über dieses Gerät gesteuert werden kann.
- Nur für den Verstärker: Die Anschlußklemmen am Ausgang (line-out) dieses Gerät an den Anschlußklemmen des Ausgangs (line-out) des Verstärkers anschließen.

Comme cet appareil a des bornes de sortie de ligne, un amplificateur et d'autres appareils peuvent être utilisés pour améliorer votre chaîne stéréo automobile.

- Connectez le fil de commande à distance (bleu avec bande blanche) au fil de commande à distance de l'autre appareil de façon qu'il puisse être commandé via cet appareil.
- Pour l'amplificateur seulement: Raccorder les bornes de sortie ligne de cet appareil aux bornes d'entrée ligne de l'amplificateur.

Amplifier / Verstärker / Amplificateur

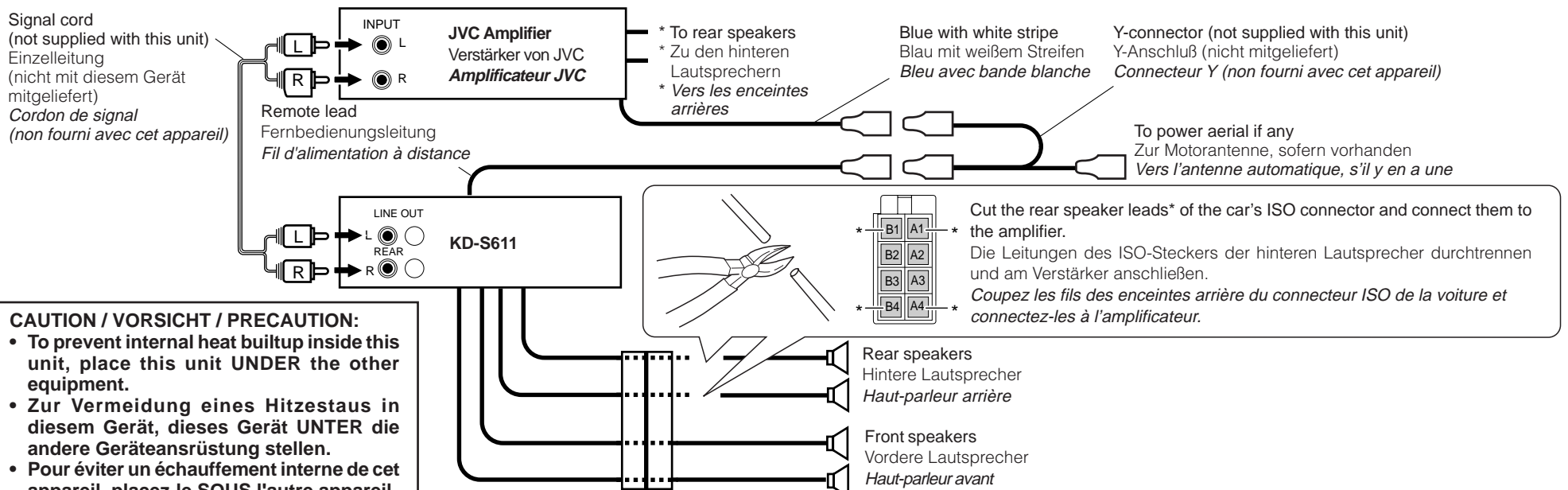

CAUTION / VORSICHT / PRECAUTION:

- To prevent internal heat buildup inside this unit, place this unit UNDER the other equipment.
- Zur Vermeidung eines Hitzestaus in diesem Gerät, dieses Gerät UNTER die andere Geräteausrüstung stellen.
- Pour éviter un échauffement interne de cet appareil, placez-le SOUS l'autre appareil.